

PRODUCT SPECIFICATIONS

Elkay Crosstown® 16 Gauge Stainless Steel, 35-1/4" x 20-1/2" x 10" Offset 40/60 Double Bowl Undermount Sink. Sink is manufactured from 16 gauge 304 Stainless Steel with a Polished Satin finish, Rear Center drain placement, and Full spray sides and bottom with Sides and Bottom pads.

Installation Type:	Undermount
Material:	304 Stainless Steel
Finish:	Polished Satin
Gauge:	16
Sound Deadening:	Full spray sides and bottom with Sides and Bottom pads
Number of Bowls:	2
Sink Dimensions:	35-1/4" x 20-1/2" x 10"
Bowl 1 Dimensions:	11-1/2" x 16" x 10"
Bowl 2 Dimensions:	20" x 18" x 10"
Drain Size:	3-1/2" (89mm)
Drain Location:	Rear Center
Minimum Cabinet Size:	39"
Mounting Hardware:	Part # 54300008 included
Template Included:	Yes
Cutout Template #:	1000001394

Template is available for download at [elkay.com](#). CAD software will be required to open the template.

Special Note: Zero radius sinks feature straight sidewalls and tight corners.



A Century of Tradition and Quality.

For more than 100 years, Elkay has been making innovative products and providing exceptional customer care. We take pride in offering plumbing products that make life easier, inspire change and leave the world a better place.

Product Compliance: ASME A112.19.3/CSA B45.4



Sinks are listed by IAPMO® as meeting the applicable requirements of the Uniform Plumbing Code®, International Plumbing Code®, and National Plumbing Code of Canada.

[Clean and Care Manual \(PDF\)](#)
[Installation Instructions \(PDF\) - 1000005239](#)
[Limited Lifetime Warranty \(PDF\)](#)

Installation Profile:

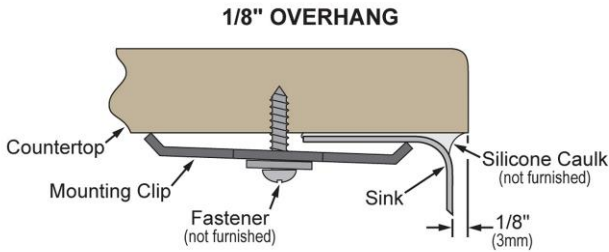

Designed to affix to the underside of any solid surface countertop.

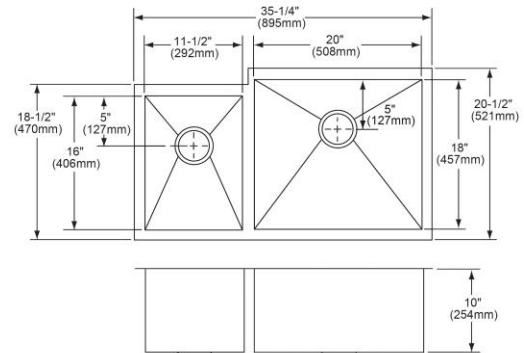

PART: _____ QTY: _____

PROJECT: _____





CONTACT: _____

DATE: _____

NOTES: _____

APPROVAL: _____

In keeping with our policy of continuing product improvement, Elkay reserves the right to change product specifications without notice. Please visit [elkay.com](#) for the most current version of Elkay product specification sheets. This specification describes an Elkay product with design, quality, and functional benefits to the user. When making a comparison of other producers' offerings, be certain these features are not overlooked.

Optional Accessories		
LK99	Elkay Deluxe 3-1/2" Drain Type 304 Stainless Steel Body Strainer Basket Rubber Seal and Tailpiece Spec Sheet (PDF)	
LKAV1031	Elkay Avado Single Hole Kitchen Faucet with Pull-down Spray and Forward Only Lever Handle Spec Sheet (PDF)	
LKAV2031	Elkay Avado Single Hole Kitchen Faucet with Semi-professional Spout and Forward Only Lever Handle Spec Sheet (PDF)	
LKFRB1116SS	Elkay Stainless Steel 10-1/2" x 15" x 7-13/16" Rinsing Basket Spec Sheet (PDF)	
LKWERBSS	Elkay Stainless Steel 15-3/8" x 12-3/8" x 5-7/16" Rinsing Basket Spec Sheet (PDF)	

In keeping with our policy of continuing product improvement, Elkay reserves the right to change product specifications without notice. Please visit elkay.com for the most current version of Elkay product specification sheets. This specification describes an Elkay product with design, quality, and functional benefits to the user. When making a comparison of other producers' offerings, be certain these features are not overlooked.